

Application

Electric actuator designed for use in industrial plants and in heating, ventilation and air-conditioning systems.



The Type 3374 Electric Actuators are linear actuators available with or without fail-safe action. They can be combined with valves from various SAMSON series.

Special features:

- 15 or 30 mm travel
- Power supply 230 V/50 Hz, 24 V/50 Hz or 110 V/60 Hz
- Synchronous motor with planetary gear
- Motor switched off by torque-dependent switches
- Mechanical override

Standard version

Type 3374 · Actuator optionally available with either integrated yoke or central attachment using a M 30 x 1.5 ring nut including necessary coupling parts.

Typetested version · Actuator with fail-safe action "actuator stem extends" for various SAMSON valves. Register number available on request.

Further versions with

- Two adjustable two-way limit switches
- Two potentiometers

Digital positioner

- Automatic travel calibration
- Different operating modes can be selected using selector switch

Setting by means of TROVIS-VIEW:

- Additional functions can be set and transferred using a PC or a memory pen
- Characteristic either linear, equal percentage or freely determinable by entering the desired points
- Priority position
- Action selectable when input signal fails

No further potentiometers are available for version with digital positioner.



Fig. 1 · Type 3374 Electric Actuator with integrated yoke attached to V 2001 Globe Valve

Principle of operation

The electric actuators consist of a reversible synchronous motor and a maintenance-free planetary gear with ball screw. The motor is switched off by torque-dependent switches when the end positions are reached or in case of overload.

The Type 3374 Actuators with integrated yoke (Fig. 3a) are primarily combined with the following valves:

V2001 Series

Type 3260 in DN 65 to DN 150

Type 3214 in DN 65 to DN 100.

The Type 3374 Actuators with central attachment are primarily combined with valves with yokes of their own:

240 Series (Fig. 3b)

Type 3214 in DN 125 to 250 (Fig. 3c)

Fail-safe action

The Type 3374 Actuators are optionally available with fail-safe action:

Actuator stem "extends": when the power supply fails, the actuator stem extends.

Actuator stem "retracts": when the power supply fails, the actuator stem retracts.

Ordering text

Electric Actuator	Type 3374- ...
Rated travel	15 or 30 mm
Version with fail-safe action	Actuator stem extends or retracts only with 15 mm travel
Electrical connection	230 V/50 Hz, 24 V/50 Hz or 110 V/60 Hz

Additional electrical equipment (see Table 1)

Two limit switches

Two potentiometers 0 to 1000 W

Digital positioner

Specifications subject to change without notice.

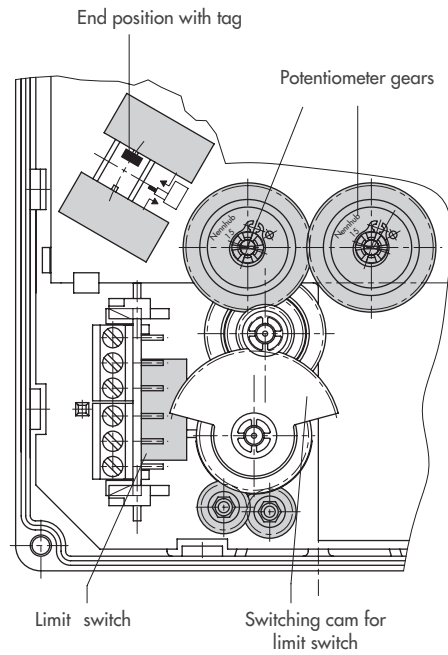
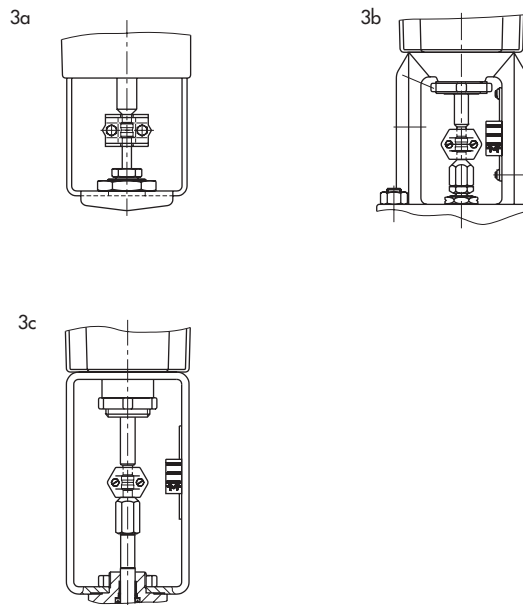

Fig. 2 · Partial view with opened cover



With integrated yoke for

3a · V 2001 Series, Type 3260 (DN 65 to DN 150)
Type 3214 (DN 65 to DN 100)

With central attachment for

3b · 240 Series
3c · Type 3214 (DN 125 to DN 250)
240 Series (Type 3241 and Type 3244)

Fig. 3 · Attachment to various valves

Table 1 · Technical data

Type	3374	-10	-11	-15	-21	-26	-31	-36
Fail-safe action		Without			With			
	Operating direction	–			Actuator stem extends		Actuator stem retracts	
Valve attachment over	Ring nut	–	–	•	–	•	–	•
	Yoke	•	•	–	•	–	•	–
Rated travel	mm	30	15	30	15		15	
Actuating time for rated travel ¹⁾	s	240/120 ¹⁾	120/60 ¹⁾	240/120 ¹⁾	120/60 ¹⁾		120/60 ¹⁾	
Actuating time in case of fail-safe action	s	–			12			
Positioning force in N	Stem extends	2500			2000			
	Stem retracts	2500			500			
Power supply		207 to 253 V/50 Hz or 21.6 to 27.6 V/50 Hz or 99 to 121 V/60 Hz						
Power consumption	VA	Max. 18						
Switchoff		Torque-dependent						
Perm. ambient temperature	°C	5 to 60						
Storage temperature	°C	–20 to +70						
Degree of protection		IP 54 according to DIN IEC 529 · Suspended mounting not permissible! IP 65 with cable glands (M20x1.5 with metal nut SW 23/24)						
Overvoltage category		II						
Design and inspection		EN 61 010 Edition 3.94						
Class of protection		II						
Noise immunity		EN 50 082 Part 2						
Noise emission		EN 50 082 Part 1						
Manual override		4 mm hex wrench · No adjustment possible after fail-safe action is triggered						
Weight	Approx. kg	3.2	3.2	3.3	3.9	4.0	3.5	3.6
Additional electrical equipment								
Limit switches		Two travel-dependent adjustable limit switches · 250 VAC, 3 A						
Potentiometers		Two potentiometers: 0 ... 1000 Ω (900 Ω at rated travel), max. 1 m · Not with version inc. positioner						
Digital positioner								
Input and output		4(0) to 20 mA · 2(0) to 10 V						
Operating modes		Can be selected using selector switch Additional settings can be determined using TROVIS-VIEW and can be transferred using a PC or memory pen						
Characteristic		Linear or freely determinable characteristic; adjustable over TROVIS-VIEW						
Travel adjustment		During automatic initialization procedure						
Interface		Data transmission with settings, operating status, error messages per SAMSON interface protocol						

¹⁾ Half the actuator time on request

Table 2 · Materials · Material no. according to DIN EN

Housing and cover	PPO glass-fiber reinforced
Central attachment and yoke	Flange: Aluminum, connecting thread M 30 x 1.5 Formed sheet: 1.4301H in injected into housing, bore hole 30 mm
Actuator stem	1.4305

Electrical connection

Version for three-point stepping signal

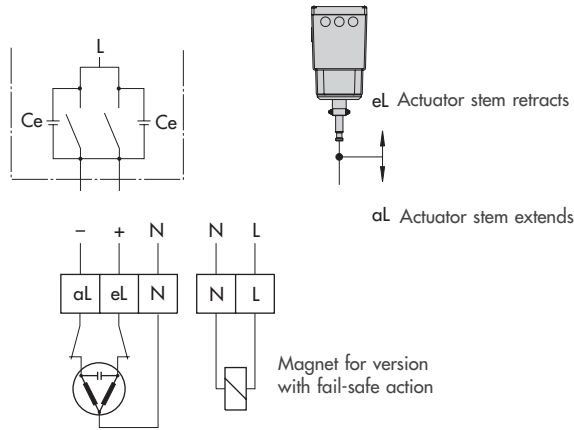

Limit switches (optional)

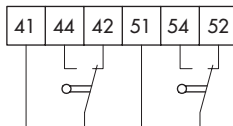

Potentiometer (optional)

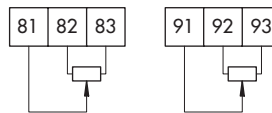

Version with digital positioner

Limit switches (optional)

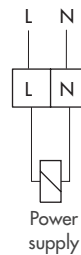
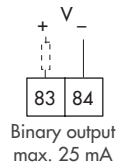
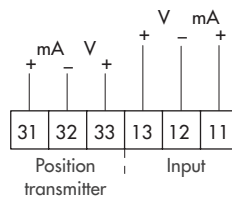
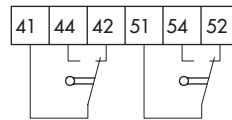

Dimensions in mm

